

Operating Instructions

OVEN

GB

GB

English,1

SX 1038N CX
SX 1038L CX

Contents

Installation, 2-3

Positioning
Electrical connection
Data plate

Description of the appliance, 4

Overall view
Control panel

Start-up and use, 5-6

Control panel lock
Setting the clock
Setting the minute minder
Starting the oven
Concealed handle
Restoring the factory settings
Standby

Modes, 7-10

Manual cooking modes
Automatic cooking modes
Programming cooking
Practical cooking advice
Cooking advice table

Precautions and tips, 11

General safety
Disposal
Respecting and conserving the environment

Care and maintenance, 12-13

Switching the appliance off
Cleaning the appliance
Cleaning the oven door
Replacing the light bulb
Assembling the sliding rack kit

Troubleshooting, 14

After Sales Service, 15

Guarantee, 16

 **Hotpoint**

Please phone us on
08448 24 24 24
to activate your
guarantee

Installation

GB

! Please keep this instruction booklet in a safe place for future reference. If the appliance is sold, given away or moved, please make sure the booklet is also passed on to the new owners so that they may benefit from the advice contained within it.

! Please read this instruction manual carefully: it contains important information concerning the safe operation, installation and maintenance of the appliance.

Positioning

! Do not let children play with the packaging material; it should be disposed of in accordance with local separated waste collection standards (see *Precautions and tips*).

! The appliance must be installed by a qualified professional in accordance with the instructions provided. Incorrect installation may damage property or cause harm to people or animals.

Built-in appliances

Use an appropriate cabinet to ensure that the appliance operates properly:

- The panels adjacent to the oven must be made of heat-resistant material.
- Cabinets with a veneer exterior must be assembled with glues which can withstand temperatures of up to 100°C.
- To install the oven **under the counter** (see *diagram*) or in a **kitchen unit**, the cabinet must have the following dimensions:

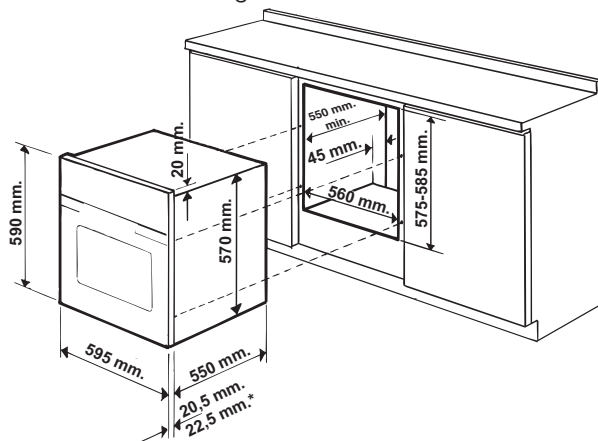

* Stainless steel models only

! The appliance must not come into contact with electrical parts once it has been installed. The indications for consumption given on the data plate have been calculated for this type of installation.

Ventilation

To ensure adequate ventilation is provided, the back panel of the cabinet must be removed. It is advisable to install the oven so that it rests on two strips of wood, or on a completely flat surface with an opening of at least 45 x 560 mm (see *diagrams*).

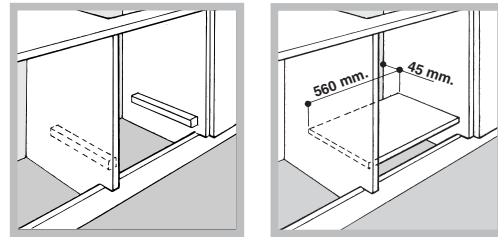

Centring and fixing

Secure the appliance to the cabinet:

- Open the oven door.
- Remove the 2 rubber plugs covering the fixing holes on the perimeter frame.
- Fix the oven to the cabinet using the 2 wood screws.
- Replace the rubber plugs.

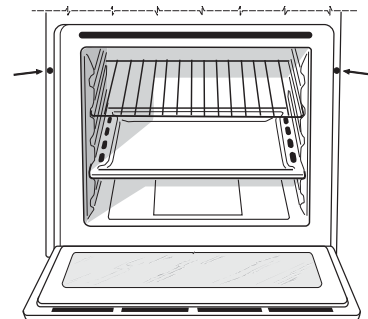

! All parts which ensure the safe operation of the appliance must not be removable without the aid of a tool.

Electrical connection

The electrical connection to the mains must be made on the appliance. The power voltage and frequency are as indicated on the rating plate.

! THIS APPLIANCE MUST BE EARTHED.

Connecting the power supply cable

To open the terminal board:

- Using a screwdriver, press on the tabs situated on each side of the terminal board cover.
- Pull open the terminal board cover.

To connect the power supply cable, proceed as follows:

- Unscrew the cable clamp screw and the contact screws L-N- \perp .
- Fasten the wires beneath the screwheads using the following colour scheme: **Blue** (N) **Brown** (L) **Yellow-Green** \perp
- Fasten the power supply cable in the corresponding cable clamp and close the cover.

Electrical Connection:

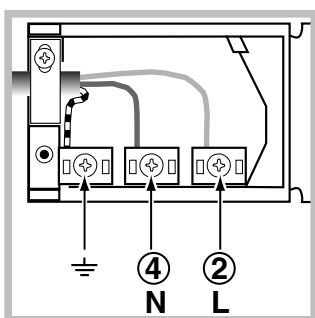

Voltage Frequency: 230 V-1+N 50Hz
Fuse Section: 16A
Supply cable: 3x1.5mm²

You can connect your oven to the system means of a terminal board. Refer to above information for the minimal cable sections and the calibration of the protective elements according to the connection. If the appliance is installed **with a junction box**, an **omnipolar circuit breaker** - with a minimum contact opening of 3mm - should be installed between the appliance and the mains.

Power cable supply connection to the electrical mains:

We recommend you use a power supply cable which is long enough to allow you to take the oven out of its recess in the event of maintenance operations (only use HAR - H 05 - RRF quality cables fitted with a plug conforming to the regulations in force. The plug must be accessible at all times.

Unplug the appliance before all operations, even when replacing the oven lamp.

Using the appliance without correct earthing is highly dangerous.

! After connecting the appliance to the flexible cable, tighten all the screws on the terminal board.

APPLIANCE SPECIFICATIONS	
Dimensions	width 43.5 cm height 32 cm depth 41.5 cm
Volume	58 l
Electrical connections	voltage: 230 - 240 V~ 50/60 Hz (see data plate) maximum power absorbed 2800-3000 W
ENERGY LABEL*	Directive 2002/40/EC on the label of electric ovens. Standard EN 50304 Declared energy consumption for Forced convection Class – heating mode: ECO.
	This appliance conforms to the following European Economic Community directives: 2006/95/EEC dated 12/12/06 (Low Voltage) and subsequent amendments - 2004/108/EEC dated 15/12/04 (Electromagnetic Compatibility) and subsequent amendments - 93/68/EEC dated 22/07/93 and subsequent amendments. - 2002/96/EEC and subsequent amendments. - 1275/2008 standby/off mode

* Without removable guide rails

Description of the appliance

GB

Overall view

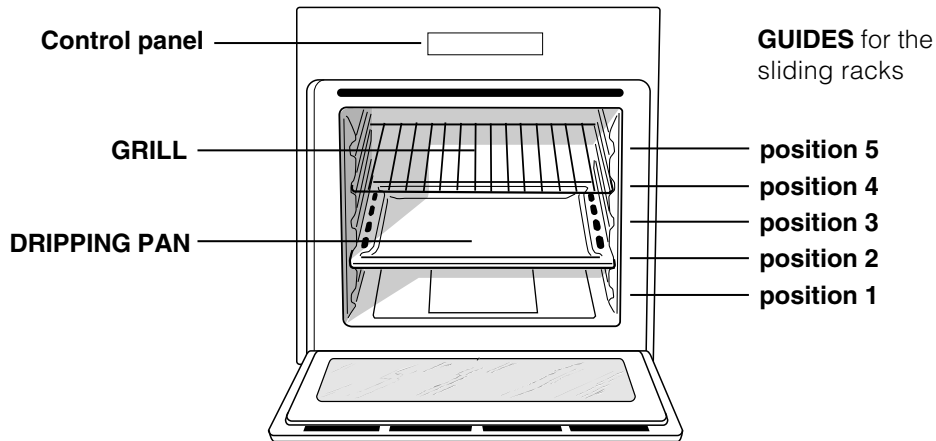

Control panel

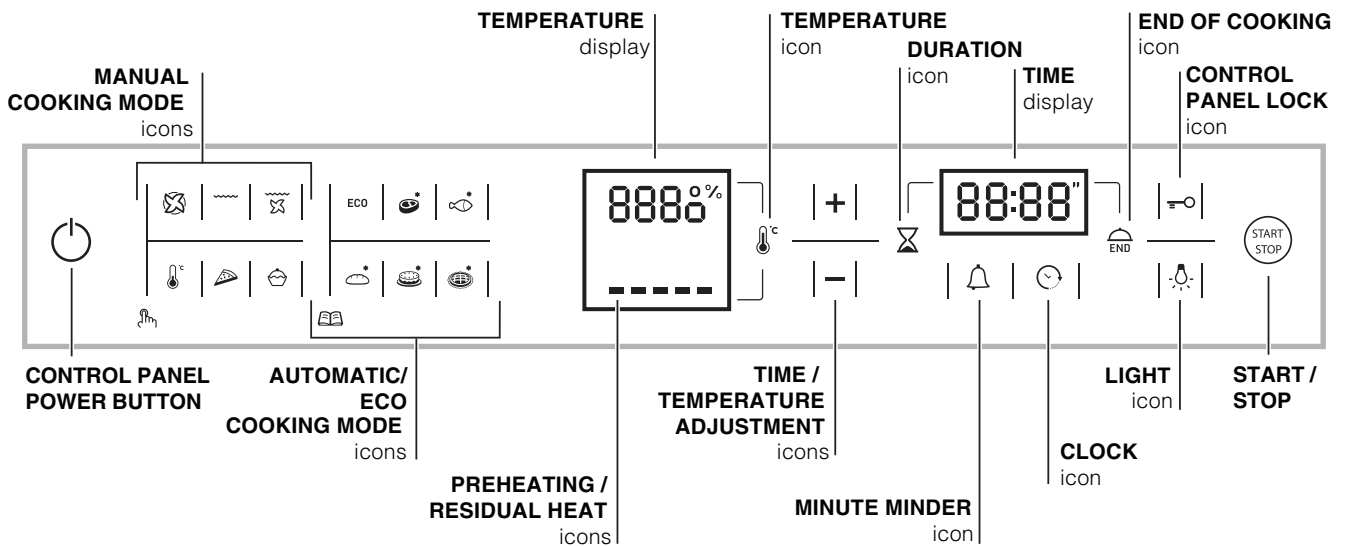

! The first time you use your appliance, heat the empty oven with its door closed at its maximum temperature for at least half an hour. Make sure that the room is well ventilated before switching the oven off and opening the oven door. The appliance may emit a slightly unpleasant odour caused by protective substances used during the manufacturing process burning away.

! To make the setting process easier, press and hold the + and - buttons to scroll through the numbers on the display rapidly.

! Each setting will automatically be stored in the appliance memory after 10 seconds.



! The touch controls cannot be activated if the user is wearing gloves.

Some models are equipped with a system of hinges which allows the door to close slowly, without the user having to follow the movement through with his/her hand. To use the system correctly, before closing the door:

- Open the door fully.
- Do not force the closing movement manually.

Control panel lock

! The control panel can be locked while the oven is off, once cooking has started or finished and during programming.

To lock the oven controls, press and hold the  button for at least 2 seconds. A buzzer will sound and the TEMPERATURE display shows the key symbol "O—n". The  icon will light up to indicate lock activation.

To deactivate the lock, press and hold the  button again for at least 2 seconds.



Setting the clock

! The clock can only be set when the oven is switched off. If the oven is in standby mode,

pressing the  button once will display the current time setting. Press it again to set the time.

After connection to the power supply network or after a blackout, the  button and the digits on the TIME display will flash for 10 seconds.

To set the clock:

1. Press the  button.
2. Adjust the hour figure using the + and - buttons.
3. Once you have reached the correct hour value, press the  button.
4. Repeat the above process to set the minutes. If a blackout occurs, it will be necessary to reset the clock. If the  icon flashes on the display, this



indicates that the clock has not been set correctly.

Setting the minute minder

! The minute minder may be set regardless of whether the oven is switched on or off. It does not switch the oven on or off.

When the set time has elapsed, the timer emits a buzzer that will automatically stop after 30 seconds or when any active button on the control panel is pressed.

To adjust the timer proceed as follows:

1. Press button .
2. Set the desired time using buttons + and -.
3. Once you have reached the desired value, press the  button again.

The lit  symbol will remind you that the minute minder is on.

To cancel the minute minder, press the  button and use the + and - buttons to set the time to 00:00.

Press button  again.

The  icon will switch off to indicate that the minute minder has been disabled.

Starting the oven

1. Switch the control panel on by pressing the  button. The appliance buzzer sounds three times (ascending) and all buttons light up in sequence.
2. Press the button corresponding to the desired cooking mode. The TEMPERATURE display shows:
 - the temperature associated with the mode, if programming manually;
 - "Auto", if programming is automatic.

The TIME display shows:

- the current time, if programming manually;
- the duration, if programming is automatic.

3. Press the  button to begin cooking.
4. The oven will begin its preheating phase, the preheating indicators will light up as the temperature rises.
5. When the preheating process has finished, a buzzer sounds and all the preheating indicator lights show that this stage has been completed: the food can then be placed in the oven.
6. During cooking it is always possible to:

- change the temperature by pressing the  °C

button, followed by the + and - buttons (*manual modes only*);

- set the duration of a cooking mode (see *Cooking Modes*);

- press the  button to stop cooking. In this case the appliance stores the temperature modified previously in its memory (*manual modes only*);

- switch off the oven by pressing the  button for 3 seconds.

7. If a blackout occurs while the oven is already in operation, an automatic system within the appliance will reactivate the cooking mode from the point at which it was interrupted, provided that the temperature has not dropped below a certain level. Programmed cooking modes which have not yet started will not be restored and must be reprogrammed (for example: a cooking mode has been programmed to start at 20:30. At 19:30 a blackout occurs. When the power supply is restored, the mode will have to be reprogrammed).

! There is no preheating stage for the GRILL mode.

! Never put objects directly on the bottom of the oven; this will prevent the enamel coating from being damaged.

! Always place cookware on the rack(s) provided.

Cooling ventilation

In order to cool down the external temperature of the oven, a cooling fan blows a stream of air between the control panel and the oven door, as well as towards the bottom of the oven door.

! Once cooking has been completed, the cooling fan continues to operate until the oven has cooled down sufficiently.

Oven light

The light comes on when the oven door is opened or when a cooking mode starts.

When models featuring *LED INSIDE* technology begin cooking, the LEDs on the door light up for improved illumination of all cooking levels.

The  button can be used to switch on the light at any time.

Residual heat indicators

The appliance is fitted with a residual heat indicator. When the oven is off, the “residual heat” bar on the display lights up to indicate high temperatures inside the oven cavity. The individual segments of the bar switch off one by one as the temperature inside the oven falls.

Concealed handle

Some models have a concealed handle built into the oven door. Simply press lightly and the push/push opening will improve your grip when opening and closing the oven. When you have finished using it, close it again by applying light pressure.

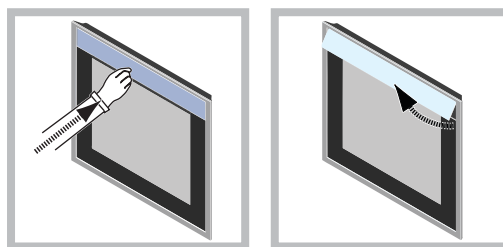

Demo mode

The oven can operate in the DEMO mode: all heating elements are deactivated, and the controls remain operative.

To activate DEMO mode, press and release button , then buttons **+** and **-** simultaneously for 6

seconds, and then press and release button . A buzzer sounds and the TEMPERATURE display shows “dEon”.

To deactivate DEMO mode, when the oven is off

press and hold button  and button **-** simultaneously for 3 seconds. A buzzer sounds and the “dEoF” message disappears from the display.

Restoring the factory settings

The oven factory settings can be restored to reset all selections made by the user (clock and customised durations). To carry out a reset, switch off the oven, then press and hold the button corresponding to the

first manual cooking mode (top left) and the  button simultaneously for 6 seconds. Once the restore procedure is complete, a buzzer will sound.

The first time the  button is pressed, the oven will behave as if it is being switched on for the first time.

Standby

This product complies with the requirements of the latest European Directive on the limitation of power consumption of the standby mode. If no buttons are pressed for 30 minutes and the control panel/door lock has not been activated, the appliance automatically reverts to standby mode. Standby mode is indicated by the high luminosity “Clock button” light. As soon as interaction with the machine resumes, the system’s operating mode is restored.

! In order to guarantee wonderfully soft and crunchy foodstuffs, the oven releases – in the form of water vapour - the humidity naturally withheld in the food itself. In this way, optimal cooking results can be achieved for all types of food.

! Every time the oven is switched on, it suggests the first manual cooking mode.

Manual cooking modes

! All cooking modes have a default cooking temperature which may be adjusted manually to a value between 30°C and 250°C as desired. In the GRILL mode, the default power level value is indicated as a percentage (%) and may also be adjusted manually. Any temperature adjustments will be stored in the appliance memory and suggested again the next time this mode is used. If the selected temperature is lower than the temperature inside the oven, the text “Hot” appears on the TEMPERATURE display. However, it will still be possible to start cooking.



MULTILEVEL mode

All heating elements and the fan are activated. Since the heat remains constant throughout the oven, the air cooks and browns food in a uniform manner. A maximum of two racks may be used at the same time.



GRILL mode

By pressing the  button, the different power levels which may be set will appear on the display; these range between 50% and 100%. The high and direct temperature of the grill is recommended for food which requires a high surface temperature. Always cook in this mode with the oven door closed (see “Practical cooking advice”).



FAN GRILLING mode

The top heating element and the rotisserie spit (where present) are activated and the fan begins to operate. During part of the cycle the circular heating element is also activated. This combination of features increases the effectiveness of the unidirectional thermal radiation provided by the heating elements through the forced circulation of the air throughout the oven.

This helps prevent food from burning on the surface and allows the heat to penetrate right into the food. Always cook in this mode with the oven door closed (see “Practical cooking advice”).

* Only available in certain models.



LOW TEMPERATURE modes

This type of cooking can be used for proving, defrosting, preparing yoghurt, heating dishes at the required speed and slow cooking at low temperatures. The temperature options are: 40, 65 and 90 °C.



PIZZA mode

The top and circular heating elements switch on and the fan begins to operate. This combination heats the oven rapidly. If you use more than one rack at a time, switch the position of the dishes halfway through the cooking process.



BAKING mode

The rear heating element and the fan are switched on, thus guaranteeing the distribution of heat in a delicate and uniform manner throughout the entire oven. This mode is ideal for baking temperature sensitive foods (such as cakes, which need to rise).

ECO mode

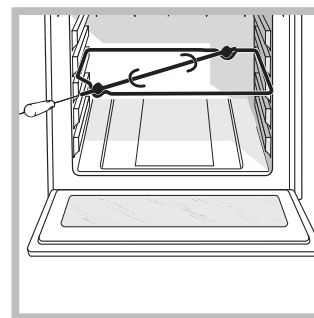

The rear heating element and the fan are switched on, thus guaranteeing the distribution of heat in a delicate and uniform manner throughout the entire oven. This energy saving mode is recommended for small dishes, ideal for heating foods and finishing off cooking.

Rotisserie spit*



To operate the rotisserie function (see diagram) proceed as follows:

1. Place the dripping pan in position 1.
2. Place the rotisserie support in position 3 and insert the spit in the hole provided on the back panel of the oven.

3. Start the rotisserie function by selecting the  or  modes.

! When  mode is on, the rotisserie will stop if the door is opened.

Automatic cooking modes

! The **temperature** and **cooking duration** are **pre-set values**, guaranteeing a perfect result every time - automatically. These values are set using the **C.O.P.® (Programmed Optimal Cooking)** system. The cooking cycle stops automatically and the oven

indicates when the dish is cooked. You may start cooking whether the oven has been **preheated** or **not**. The cooking duration can be customised according to personal tastes, modifying it by $\pm 5/20$ minutes depending on the selected programme. If the value is modified before cooking begins, it is stored in the appliance memory and suggested again when that cooking mode is next used. If the temperature inside the oven is higher than the suggested value for the selected mode, the text "Hot" appears on the TEMPERATURE display and it will not be possible to begin cooking; wait for the oven to cool.

! When the cooking stage has been reached, the oven buzzer sounds.

! Do not open the oven door as this will disrupt the cooking time and temperature.



BEEF mode

Use this function to cook beef, pork and lamb. Place the food inside the oven while it is still cold. The dish may also be placed in a preheated oven.



FISH FILLETS mode

This function is ideal for cooking small-medium fillets. Place the food inside the oven while it is still cold.



BREAD mode

Use this function to bake bread. To obtain the best results, we recommend that you carefully observe the instructions below:

- follow the recipe;
- do not exceed the **maximum weight** of the dripping pan;
- **remember to pour 100 ml of cold water into the baking tray in position 5.**
- The dough must be left to rise at room temperature for 1 – 1 ½ hours (depending on the room temperature) or until the dough has doubled in size.

Recipe for BREAD:

1 Dripping pan holding 1000 g Max, lower level
2 Dripping pans each holding 1000 g Max, medium and lower levels

Recipe for 1000 g of dough: 600 g flour, 360 g water, 11g salt, 25 g fresh yeast (or 2 sachets of powder yeast)

Method:

- Mix the flour and salt in a large bowl.
- Dilute the yeast in lukewarm water (approximately 35 degrees).
- Make a small well in the mound of flour.
- Pour in the water and yeast mixture.
- Knead the dough by stretching and folding it over itself with the palm of your hand for 10 minutes until it has a uniform consistency and is not too sticky.
- Form the dough into a ball shape, place it in a large bowl and cover it with transparent plastic wrap to prevent the surface of the dough from drying out. Select the manual LOW TEMPERATURE function on the oven and set the temperature to 40°C. Place the bowl inside and leave the dough to rise for approximately 1 hour (the dough should double in volume).
- Cut the dough into equal sized loaves.
- Place them in the dripping pan, on a sheet of baking paper.
- Dust the loaves with flour.
- Make incisions on the loaves.
- Place the food inside the oven while it is still cold.
- Start the  BREAD cooking mode.
- Once baked, leave the loaves on one of the grill racks until they have cooled completely.



BAKED CAKES mode

This function is ideal for cooking desserts which are made using natural yeast, baking powder and desserts which contain no yeast. Place the dish in the oven while it is still cold. The dish may also be placed in a preheated oven.





TARTS mode





This function is ideal for all tart recipes (which normally need to be heated well from underneath). Place the food inside the oven while it is still cold. The dish may also be placed in a preheated oven.

Programming cooking

! A cooking mode must be selected before programming can take place.

! Once a cooking mode has been selected, the  button is activated; it will then be possible to program a duration. The  button is only activated after a duration has been set; it will then be possible to program a delayed start.





Programming the duration



1. Press the  button; the  button and the numbers on the TIME display will flash.
2. Set the duration by pressing buttons **+** and **-**.
3. Once you have reached the desired duration, press the  button again.
4. Press the  button to begin cooking.
5. When cooking has finished, "END" appears on the TEMPERATURE display and a buzzer sounds.
 - For example: it is 9:00 a.m. and a duration of 1 hour and 15 minutes is programmed. The programme will stop automatically at 10:15 a.m.

Programming delayed cooking

! A cooking duration must be set before the cooking end time can be scheduled.

! For the delayed programming to work properly, the clock should be set to the correct time.

1. Press the  button and repeat steps 1 to 3 as described for the duration setting.
2. Then press the  button and set the end time using the **+** and **-** buttons.
3. Once you have reached the desired end time, press the  button again.
4. Press the  button to activate the programmed mode.

The  and  buttons will flash alternately to indicate that programming has taken place; in the time before cooking starts, the TIME display will show the duration and the cooking end time alternately.

5. Once cooking has finished, "END" appears on the TEMPERATURE display and a buzzer sounds.
 - For example: it is 9:00 a.m. and a time of 1 hour and 15 minutes is programmed, while the end time is set to 12:30. The programme will start automatically at 11:15 a.m.

To cancel programming press the  button.

Practical cooking advice

! Do not place racks in position 1 and 5 during fan-assisted cooking. This is because excessive direct heat can burn temperature sensitive foods.

! In the GRILL and FAN GRILLING cooking modes, particularly when using the rotisserie spit, place the dripping pan in position 1 to collect cooking residues (fat and/or grease).

MULTILEVEL

- Use positions 2 and 4, placing the food which requires more heat on 2.
- Place the dripping pan on the bottom and the rack on top.

GRILL

- Place the rack in position 3 or 4. Position the food in the centre of the rack.
- We recommend that the temperature is set to its maximum level. The top heating element is regulated by a thermostat and may not always operate constantly.

PIZZA

- Use a lightweight aluminium pizza pan. Place it on the rack provided.
For a crispy crust, do not use the dripping pan as this extends the total cooking duration and prevents the crust from forming.
- If the pizza has a lot of toppings, we recommend adding the mozzarella cheese to the top of the pizza halfway through the cooking process.

Cooking advice table

Modes	Foods	Weight (in kg)	Rack position		Preheating	Recommended Temperature (°C)	Cooking duration (minutes)
			Standard guide rails	Sliding guide rails			
Manual							
Multilevel*	Pizza on 2 racks	1+1	2 and 4	1 and 3	yes	220-230	20-25
	Pies on two racks/cakes on 2 racks		2 and 4	1 and 3	yes	180	30-35
	Sponge cake on 2 racks (on the dripping pan)		2 and 4	1 and 3	yes	170	20-30
	Roast chicken + potatoes		1 and 2/3	1 and 3	yes	200-210	65-75
	Lamb		2	1	yes	190-200	45-50
	Mackerel		1 or 2	1	yes	180	30-35
	Lasagne		2	1	yes	190-200	35-40
	Cream puffs on 3 racks		1 and 3 and 5	1 and 2 and 4	yes	190	20-25
	Biscuits on 3 racks		1 and 3 and 5	1 and 2 and 4	yes	190	10-20
	Cheese puffs on 2 racks		2 and 4	1 and 3	yes	210	20-25
	Savoury pies		1 and 3	1 and 3	yes	200	25-35
Grill*	Mackerel	1	4	3	no	100%	10-20
	Sole and cuttlefish	0,7	4	3	no	100%	10-15
	Squid and prawn kebabs	0,7	4	3	no	100%	10-15
	Cod fillet	0,7	4	3	no	100%	10-15
	Grilled vegetables	0,5	3 or 4	2 or 3	no	100%	15-20
	Veal steak	0,8	4	3	no	100%	10-20
	Sausages	0,7	4	3	no	100%	10-20
	Hamburgers	n° 4 or 5	4	3	no	100%	10-12
	Toasted sandwiches (or toast)	n° 4 or 6	4	3	no	100%	3-5
	Spit-roast chicken using rotisserie spit (where present)	1	-	-	no	100%	70-80
	Spit-roast lamb using rotisserie spit (where present)	1	-	-	no	100%	70-80
	Fan grilling*	Grilled chicken	1,5	2	2	no	210
Cuttlefish		1	2	2	no	200	30-35
Spit-roast chicken using rotisserie spit (where present)		1,5	-	-	no	210	70-80
Spit-roast duck using rotisserie spit (where present)		1,5	-	-	no	210	60-70
Roast veal or beef		1	2	2	no	210	60-75
Roast pork		1	2	2	no	210	70-80
Lamb		1	2	2	no	210	40-45
Low temperature*	Proving / Defrosting	-	2	1	no	40	-
	White meringues	-	2	1	no	65	8-12 ore
	Meat / Fish	-	2	1	no	90	90-180
Pizza*	Pizza	0,5	2	1	yes	220	15-20
	Focaccia bread	0,5	2	1	yes	200	20-25
Baking*	Tarts	0,5	2 or 3	1 or 2	yes	180	25-35
	Fruit cakes	1	2 or 3	1 or 2	yes	180	40-50
	Sponge cake made with yoghurt	0,7	2 or 3	1 or 2	yes	180	45-55
	Small cakes on 2 racks	0,7	2 and 4	1 and 3	yes	180-190	20-25
	Sponge cake	0,6	2 or 3	1 or 2	yes	160-170	35-40
	Cream puffs on 2 racks	0,7	1 and 3	1 and 2	yes	180-190	20-30
	Biscuits on 2 racks	0,7	1 and 3	1 and 2	yes	180	20-25
	Filled pancakes	0,8	2	1	yes	200	30-35
	Meringues on 2 racks	0,5	1 and 3	1 and 2	yes	90	180
	Cheese puffs	0,5	2	1	yes	210	20-25
ECO*	Tarts	0,5	2 or 3	1 or 2	yes	200	30-40
	Small cakes on 2 racks	0,7	2 and 4	1 and 3	yes	200	20-25
	Sponge cake	0,6	2 or 3	1 or 2	yes	180	35-40
	Biscuits on 2 racks	0,7	1 and 3	1 and 2	yes	200	20-25
	Cheese puffs	0,5	2	1	yes	200	20-30
	Meringues on 2 racks	0,5	1 and 3	1 and 2	yes	90	180
	Fish fillets	0,5	2 or 3	1 or 2	yes	200	20-25
	Lamb skewers	0,5	2 or 3	1 or 2	yes	200	20-25
Hamburgers	0,5	2 or 3	1 or 2	yes	200	20-25	
Automatic**							
Beef	Roast dishes	1	2 or 3	2	no		
Fish fillets	Cod	0,4-0,5	2 or 3	2	no		
	Perch	0,4-0,5	2 or 3	2	no		
	Trout	0,4-0,5	2 or 3	2	no		
Bread***	Bread (see recipe)	1	1 or 2	1	no		
Baked cakes	Baked cakes	1	2 or 3	2	no		
Tarts	Tarts	0,5	2 or 3	2	no		

* The cooking times listed above are intended as guidelines only and may be modified according to personal tastes. Oven preheating times are set as standard and may not be modified manually.

** The duration of the automatic cooking functions are set by default. The values can be modified by the user, starting with the default duration.

*** As stated in the recipe, pour 100 g (1dl) water into the dripping pan in position 5.

! This appliance has been designed and manufactured in compliance with international safety standards. The following warnings are provided for safety reasons and must be read carefully.

General safety

- The appliance was designed for domestic use inside the home and is not intended for commercial or industrial use.
- The appliance must not be installed outdoors, even in covered areas. It is extremely dangerous to leave the appliance exposed to rain and storms.
- When moving or positioning the appliance, always use the handles provided on the sides of the oven.
- Do not touch the appliance while barefoot or with wet or damp hands and feet.
- **The appliance must be used by adults only for the preparation of food, in accordance with the instructions provided in this booklet. Any other use of the appliance (e.g. for heating the room) constitutes improper use and is dangerous. The manufacturer may not be held responsible for any damage caused as a result of improper, incorrect and unreasonable use of the appliance.**
- **Do not touch the heating elements or certain parts of the oven door when the appliance is in use; these parts become extremely hot. Keep children well away from the appliance.**
- Make sure that the power supply cables of other electrical appliances do not come into contact with the hot parts of the oven.
- The ventilation and heat dispersal openings must never be obstructed.
- Always grip the oven door handle in the centre: the ends may be hot.
- Always use oven gloves when placing cookware in the oven or when removing it.
- Do not use aluminium foil to line the bottom of the oven.
- Do not place flammable materials in the oven: if the appliance is switched on accidentally, the materials could catch fire.
- When unplugging the appliance, always pull the plug from the mains socket; do not pull on the cable.
- Do not perform any cleaning or maintenance work without having disconnected the appliance from the electricity mains.
- If the event of malfunctions, under no circumstances should you attempt to perform the repairs yourself. Contact an authorised Service Centre (*see Assistance*).
- Do not rest objects on the open oven door.
- Do not let children play with the appliance.

- The appliance should not be operated by people (including children) with reduced physical, sensory or mental capacities, by inexperienced individuals or by anyone who is not familiar with the product. These individuals should, at the very least, be supervised by someone who assumes responsibility for their safety or receive preliminary instructions relating to the operation of the appliance.

Disposal

- When disposing of packaging material: observe local legislation so that the packaging may be reused.
- The European Directive 2002/96/EC relating to Waste Electrical and Electronic Equipment (WEEE) states that household appliances should not be disposed of using the normal solid urban waste cycle. Exhausted appliances should be collected separately in order to optimise the cost of re-using and recycling the materials inside the machine, while preventing potential damage to the atmosphere and to public health. The crossed-out dustbin is marked on all products to remind the owner of their obligations regarding separated waste collection.
For further information relating to the correct disposal of exhausted household appliances, owners may contact the relevant public service or their local dealer.

Respecting and conserving the environment

- You can help to reduce the peak load of the electricity supply network companies by using the oven in the hours between late afternoon and the early hours of the morning. The cooking mode programming options, the “delayed cooking” mode (*see Cooking modes*) and “delayed automatic cleaning” mode (*see Care and Maintenance*) in particular, enable the user to organise their time efficiently.
 - Always keep the oven door closed when using the GRILL and FAN GRILLING modes: this will achieve improved results while saving energy (approximately 10%).
 - Check the door seals regularly and wipe them clean to ensure they are free of debris so that they adhere properly to the door, thus avoiding the dispersal of heat.
- ! This product complies with the requirements of the latest European Directive on the limitation of power consumption of the standby mode.

Care and maintenance

GB

Switching the appliance off

Disconnect your appliance from the electricity supply before carrying out any work on it.

Cleaning the appliance

- Slight differences in colour on the front of the oven are due to the different materials used, i.e. glass, plastic or metal.
- Any shady areas resembling grooves on the oven door glass are caused by reflections from the oven light.
- The enamel is branded at very high temperatures. This process may cause colour variations. This is normal and will not affect appliance operation in any way. The thin edges of the sheet metal cannot be entirely enamelled and may therefore appear to be unfinished. This will not affect the rust protection.
- The stainless steel or enamel-coated external parts and the rubber seals may be cleaned using a sponge that has been soaked in lukewarm water and neutral soap. Use specialised products for the removal of stubborn stains. After cleaning, rinse and dry thoroughly. Do not use abrasive powders or corrosive substances.
- The inside of the oven should ideally be cleaned after each use, while it is still lukewarm. Use hot water and detergent, then rinse well and dry with a soft cloth. Do not use abrasive products.
- All accessories - with the exception of the sliding racks - can be washed like everyday crockery, and are even dishwasher safe.
- We recommend that detergents are not sprayed directly onto the control panel, but that a sponge is used instead.

! Never use steam cleaners or pressure cleaners on the appliance.

Cleaning the oven door

! The door of LED INSIDE models cannot be removed.

Clean the glass part of the oven door using a sponge and a non-abrasive cleaning product, then dry thoroughly with a soft cloth. Do not use rough abrasive material or sharp metal scrapers as these could scratch the surface and cause the glass to crack.

For more thorough cleaning purposes, the oven door may be removed:

1. Open the oven door fully (*see diagram*).
2. Use a screwdriver to lift up and turn the small levers **F** located on the two hinges (*see diagram*).

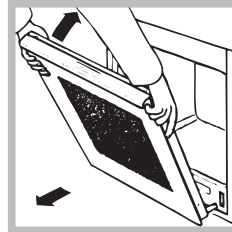
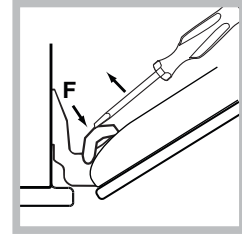
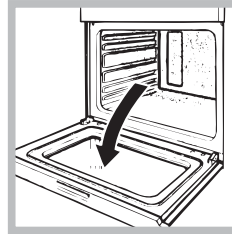

3. Grip the door on the two outer sides and close it approximately half way. Pull the door towards you, lifting it out of its slot (*see diagram*). To replace the door, reverse this sequence.

Inspecting the seals

Check the door seals around the oven regularly. If the seals are damaged, please contact your nearest Service Centre (*see Assistance*). We recommend that the oven is not used until the seals have been replaced.

Replacing the light bulb

To replace the oven light bulb:

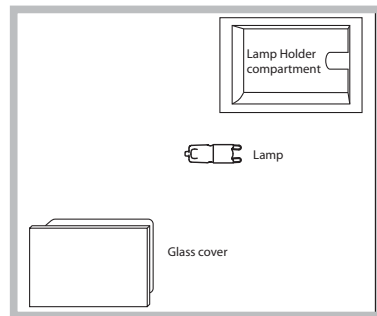

1. Remove the glass cover of the lamp-holder.
2. Remove the light bulb and replace it with a similar one: halogen lamp voltage 230 V, wattage 25 W, cap G 9.

3. Replace the glass cover (*see diagram*).

! Do not touch the light bulb directly with your hands.

Sliding rack kit assembly

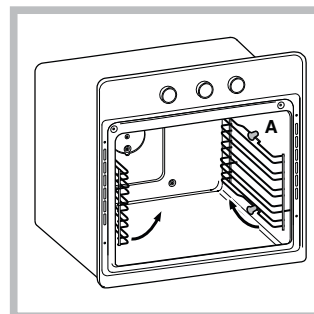

To assemble the sliding racks:

1. Remove the two frames, lifting them away from the spacers **A** (*see figure*).

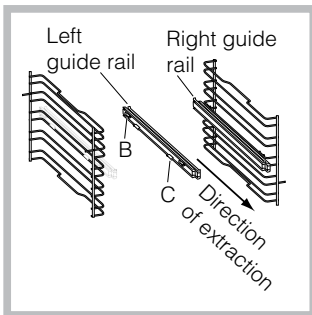

2. Choose which shelf to use with the sliding rack. Paying attention to the direction in which the sliding rack is to be extracted, position joint B and then joint C on the frame.

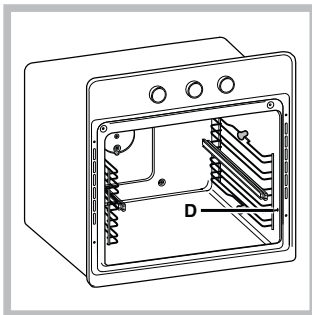

3. Secure the two frames with the guide rails using the holes provided on the oven walls (*see diagram*). The holes for the left frame are situated at the top, while the holes for the right frame are at the bottom.

4. Finally, fit the frames

on the spacers A.

! Do not place the sliding racks in position 5.

Side and rear catalytic liners*

These are panels coated with a special enamel, which is able to absorb the fat released by food as it cooks.

This enamel is quite strong, so that the various accessories (racks, dripping pans, etc.) can slide along them without damaging them. White marks may appear on the surfaces; these are not a cause for concern.

Nevertheless, the following should be avoided:

- scraping the enamel with sharp objects (a knife, for example);
- using detergents or abrasive materials.

* Only available in certain models.

Troubleshooting

GB

Problem	Possible cause	Solution
The "Clock button" and the digits on the display flash.	The appliance has just been connected to the electricity mains or there has been a blackout.	Set the clock.
A programmed cooking mode does not start.	There has been a blackout.	Reprogram the cooking mode.
Only the high luminosity "Clock button" is lit.	The appliance is in standby mode.	Press any button to exit standby mode.
An automatic mode has been selected. "Hot" appears on the display and cooking does not start.	The temperature inside the oven is higher than the suggested value for the selected mode.	Wait for the oven to cool down.
Fan-assisted cooking has been selected and the food looks burnt.	Positions 1 and 5: the direct heat could cause temperature-sensitive foods to burn.	We recommend switching dripping pan positions halfway through cooking.

After Sales Service

No one is better placed to care for your Hotpoint appliance during the course of its working life than us – the manufacturer.

Essential Contact Information

Hotpoint Service

We are the largest service team in the country offering you access to 400 skilled telephone advisors and 1000 fully qualified engineers on call to ensure you receive fast, reliable, local service.

UK: 08448 224 224
Republic of Ireland: 0818 313 413
www.hotpointservice.co.uk

Please note: Our advisors will require the following information:

Model number:

Serial number:

Parts and Accessories

We supply a full range of genuine replacement parts as well as accessory products that protect and hygienically clean your appliance to keep it looking good and functioning efficiently throughout its life.

UK: 08448 225 225
Republic of Ireland: 0818 313 413
www.hotpointservice.co.uk

Appliance Registration

We want to give you additional benefits of Hotpoint ownership. To activate your free 5 year parts guarantee you must register your appliance with us.

UK: 08448 24 24 24
Republic of Ireland: 01 230 0800
www.hotpointservice.co.uk

Indesit Company UK Ltd. Morley Way, Peterborough, PE2 9JB
Indesit Company Unit 49 Airways Industrial Estate, Dublin 17

Recycling and Disposal Information

As part of Hotpoint's continued commitment to helping the environment, Hotpoint reserves the right to use quality, recycled components to keep down customer costs and minimise material wastage.

Please dispose of packaging and old appliances carefully. To minimise the risk of injury to children, remove the door, plug, and cut the mains cable off flush with the appliance. Dispose of these parts separately to ensure that the appliance can no longer be plugged into mains socket, and the door cannot be locked shut.

Guarantee

12 months Parts and Labour Guarantee

Your appliance has the benefit of our manufacturer's guarantee, which covers the cost of breakdown repairs for twelve months from the date of purchase.

This gives you the reassurance that if, within that time, your appliance is proven to be defective because of either workmanship or materials, we will, at our discretion, either repair or replace the appliance at no cost to you.

This guarantee is subject to the following conditions:

- The appliance has been installed and operated correctly and in accordance with our operating and maintenance instructions.
- The appliance is used only on the electricity or gas supply printed on the rating plate.
- The appliance has been used for normal domestic purposes only.
- The appliance has not been altered, serviced, maintained, dismantled, or otherwise interfered with by any person not authorised by us.
- Any repair work must be undertaken by us or our appointed agent.
- Any parts removed during repair work or any appliance that is replaced become our property.
- The appliance is used in the United Kingdom or Republic of Ireland.

The guarantee does not cover:

- Damage resulting from transportation, improper use, neglect or interference or as a result of improper installation.
- Replacement of any consumable item or accessory. These included but not limited to: plugs, cables, batteries, light bulbs, fluorescent tubes and starters, covers and filters.
- Replacement of any removable parts made of glass or plastic.

THIS GUARANTEE WILL NOT APPLY IF THE APPLIANCE HAS BEEN USED IN COMMERCIAL OR NON-DOMESTIC PREMISES.

5 Year Parts Guarantee

Hotpoint also offers you a free 5 year parts guarantee. This additional guarantee is conditional on you registering your appliance with us and the parts being fitted by one of our authorised engineers. There will be a charge for our engineer's time. To activate the extra parts warranty on your appliance, simply call our registration line on **08448 24 24 24 (Republic of Ireland 01 230 0800)**

Extended Guarantees

We offer a selection of protection plans that enable you to fully cover yourself against the expense of repair bills for the life of your policy. To find the ideal plan for you please call our advice line on **08448 226 226 (Republic of Ireland 01 230 0233)**.

Free Helpdesk Service

We have a dedicated team who can provide free advice and assistance with your appliance if you experience any technical difficulties within the first 90 days of ownership. Simply call our Hotpoint Service Hotline on **08448 224 224 (Republic of Ireland 0818 313 413)** for telephone assistance, or, where necessary, to arrange for an engineer to call.